

# Isokern Magnum 72" Fireplace

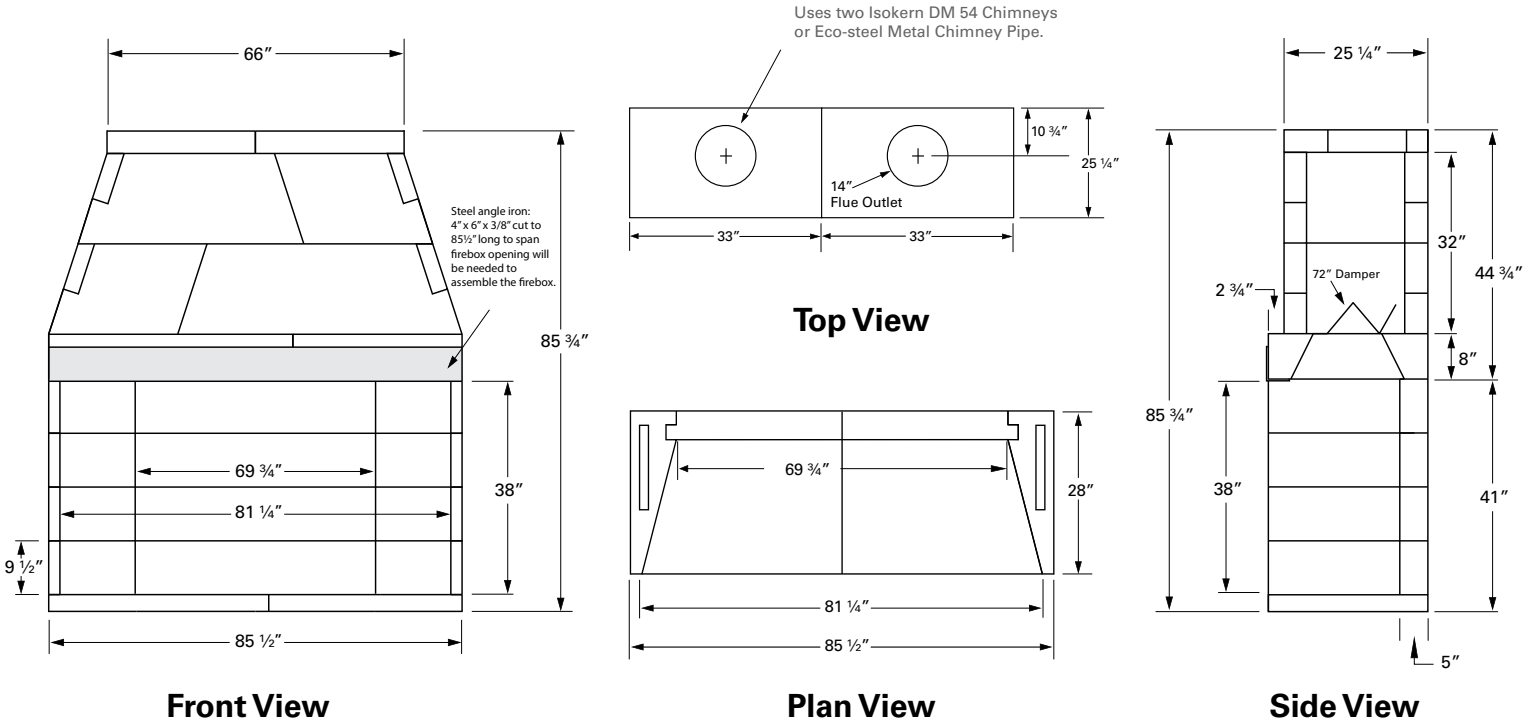

6899 Phillips Industrial Blvd. • Jacksonville, FL 32256

Project Name: \_\_\_\_\_ Location: \_\_\_\_\_



## MINIMUM FRAMING DIMENSIONS

Framing dimensions maintain 1 1/2" clearance to combustibles. Refer to product manual for further installation instructions.

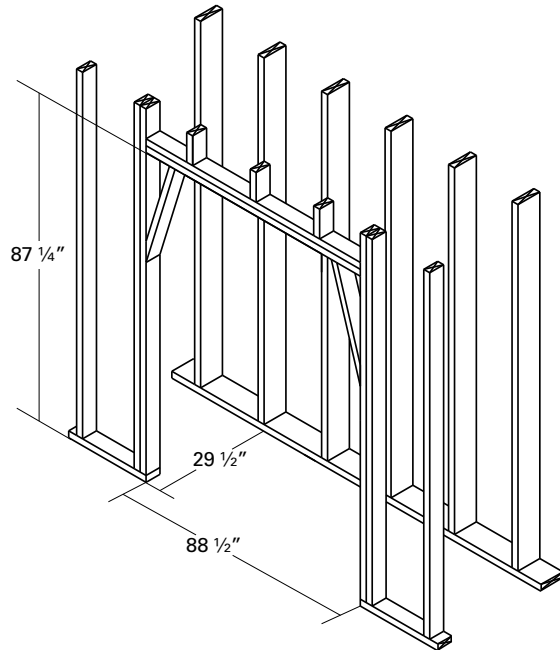

### FIREPLACE OPTIONS

- Hearth Height: \_\_\_\_\_
- Brick Type: \_\_\_\_\_
- Brick Color: \_\_\_\_\_
- Brick Pattern: \_\_\_\_\_
- Damper: \_\_\_\_\_
- Chimney Type: \_\_\_\_\_
- Offset: \_\_\_\_\_
- Other Options: \_\_\_\_\_
- Spark Arrestor/Termination: \_\_\_\_\_
- Energex RSHT Chimney Fan: \_\_\_\_\_
- Decorative Termination: \_\_\_\_\_
- Gas Log Set: \_\_\_\_\_
- Wood Grate: \_\_\_\_\_

Notes: \_\_\_\_\_  
 \_\_\_\_\_  
 \_\_\_\_\_  
 \_\_\_\_\_

The total weight for the Magnum 72" fireplace is approximately 2952 lbs. This dry weight includes fireplace pumice components only, additional weight from mortar, damper, firebrick and chimney not included.