

# Isokern Magnum 60" Fireplace

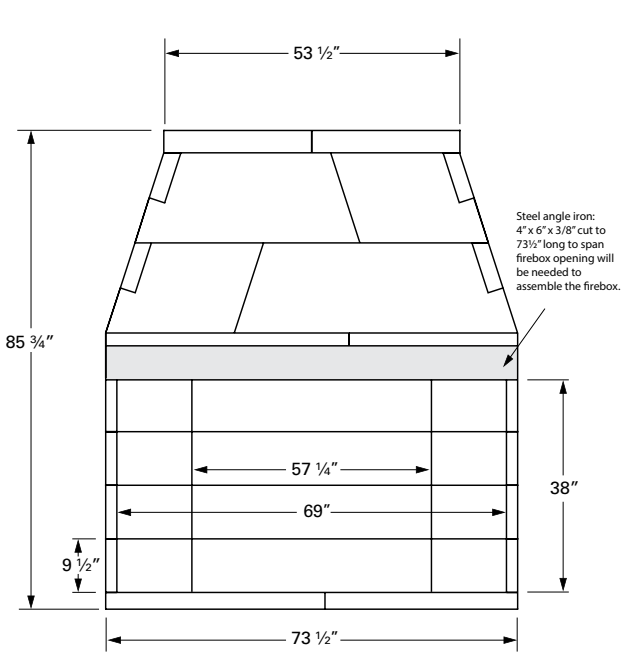

6899 Phillips Industrial Blvd. • Jacksonville, FL 32256

Project Name: \_\_\_\_\_ Location: \_\_\_\_\_



**Front View**

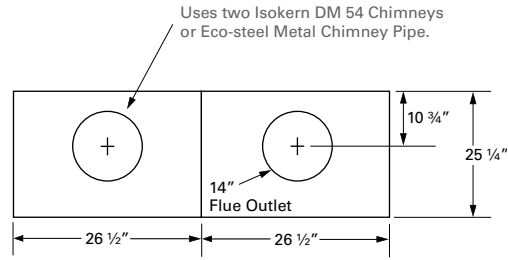

**Top View**

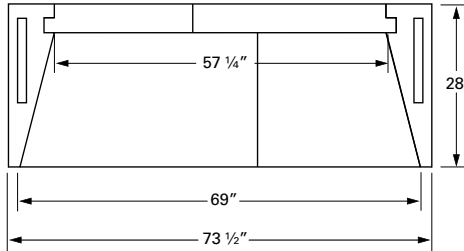

**Plan View**

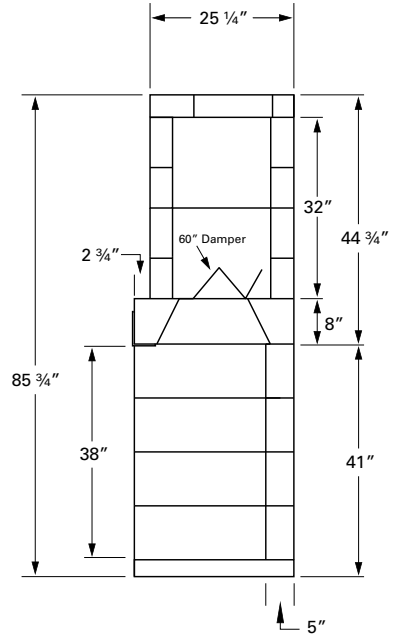

**Side View**

## FIREPLACE OPTIONS

- Hearth Height: \_\_\_\_\_
- Brick Type: \_\_\_\_\_
- Brick Color: \_\_\_\_\_
- Brick Pattern: \_\_\_\_\_
- Damper: \_\_\_\_\_
- Chimney Type: \_\_\_\_\_
- Offset: \_\_\_\_\_
- Other Options: \_\_\_\_\_
- Spark Arrestor/Termination: \_\_\_\_\_
- Energex RSHT Chimney Fan: \_\_\_\_\_
- Decorative Termination: \_\_\_\_\_
- Gas Log Set: \_\_\_\_\_
- Wood Grate: \_\_\_\_\_

Notes: \_\_\_\_\_  
 \_\_\_\_\_  
 \_\_\_\_\_  
 \_\_\_\_\_

## MINIMUM FRAMING DIMENSIONS

Framing dimensions maintain 1 1/2" clearance to combustibles. Refer to product manual for further installation instructions.

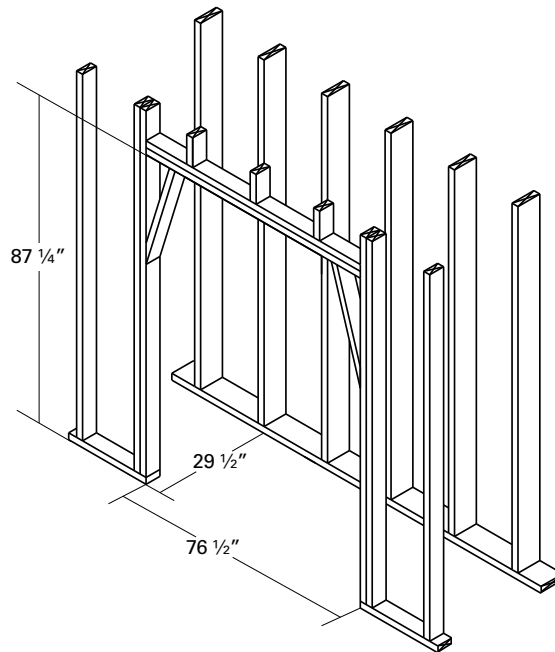

The total weight for the Magnum 60" fireplace is approximately 2652 lbs. This dry weight includes fireplace pumice components only, additional weight from mortar, damper, firebrick and chimney not included.